

Alfatec

machines at your service



HR 300

LINEA LEGNO | WOOD LINE | LIGNE BOIS

*Centro di lavoro CNC orizzontale
Horizontal CNC machining centre
Centre d'usinage horizontal a CN*

HR 300

CNC ORIZZONTALE - LINEA LEGNO



Centro di lavoro orizzontale a controllo numerico a tre quattro e cinque assi controllati configurato con piano di lavoro in bachelite.

I pezzi da lavorare vengono posizionati su battute a scomparsa e trattenuti dal vuoto per mezzo di ventose a depressione con posizionamento rapido e regolabile, o tramite piano martire, su tutta l'area di lavoro. Questo rende la macchina pratica e versatile.



Horizontal 3-, 4- and 5-axis CNC machining centre, equipped with bakelite fixed working table.

The pieces to be processed are positioned on retractable stops and retained by the vacuum by means of vacuum suction cups with rapid positioning, or by means of a martyr surface, over the entire work area. This makes the machine practical and versatile.



Centre d'usinage horizontal à contrôle numérique à trois, quatre et cinq axes contrôlés, configuré avec une table de travail en bakélite.

Les pièces à usiner sont placées sur des butées escamotables et maintenues au moyen de ventouses à dépression à positionnement rapide sur toute la zone de travail, rendant la machine pratique et versatile.



CARATTERISTICHE

Controllo moderno e facile da utilizzare
Sistema operativo Windows 10

FUNZIONI DI SERIE:

- Convertitore di files eseguiti in CAD e salvati in DXF
- Lavorazione in speculare senza ulteriore programmazione
- Foratura controllata su 5 lati
- Svuotamento tasche in automatico
- Programma per eseguire scritte
- Possibilità di importare/esportare file in formato DXF e ISO
- Possibilità di creare nuove macro personalizzare anche automaticamente
- Programmazione parametrica per massima flessibilità
- Creazione di facce fittizie per lavorazioni speciali (lavorazioni eseguite su facce inclinate e non ortogonali)
- Visualizzazione grafica per la corretta posizione delle ventose
- Squadratura
- Squadratura con raggio di raccordo concava e convessa
- Funzione di controllo velocità avanzamento assi in riferimento al raggio del profilo da eseguire
- Macro preimpostata per lavorazione porta
- Magazzino utensili automatico
- Possibilità di equipaggiare la macchina con un secondo magazzino utensili lineare
- Possibilità di equipaggiare la macchina con magazzino utensili rotativo

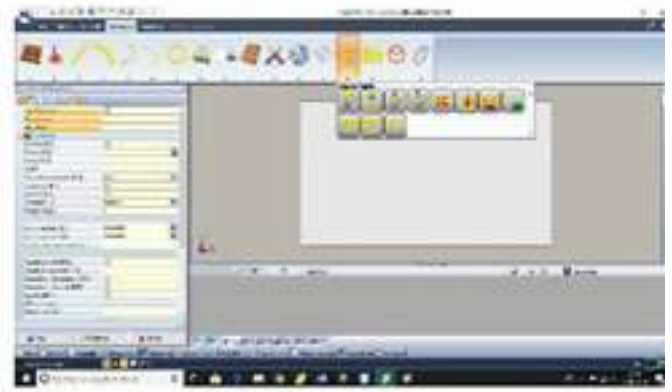
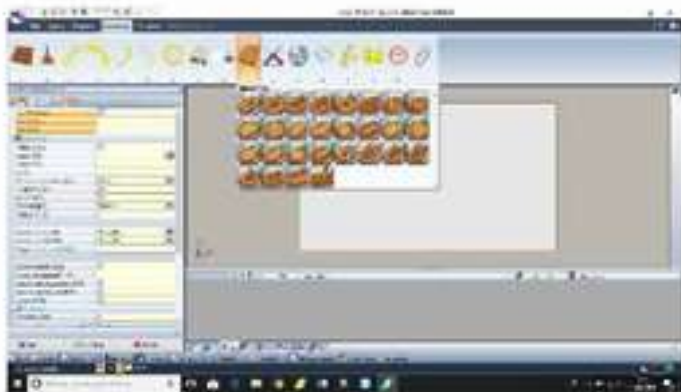

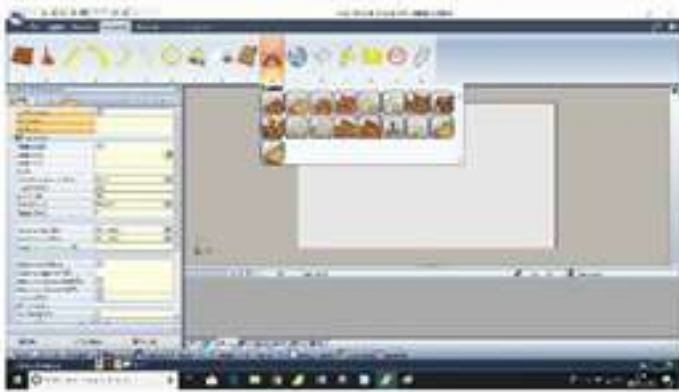

CHARACTERISTIC

Modern and easy-to-use CNC
Windows 10 Operating System

STANDARD FUNCTIONS:

- Converter of files executed in CAD and saved in DXF format
- Specular machining without further programming
- Controlled drilling on 5 sides
- Automatic milling of pockets
- Software for writing operations
- Possibility to import and / or export files in dxf and iso format
- Possibility to create new custom macros also independently
- Parametric programming for maximum flexibility
- Creation of fictive faces for special processing (works carried out on faces inclined and not orthogonal)
- Graphic display for the correct position of the suction cups
- Squaring
- Squaring with concave and convex joint radius
- Axis feeding speed control function in reference to the radius of profile to perform
- Preset macro for door processing
- Automatic tool changer
- Possibility of equipping the machine with a second linear tool magazine
- Possibility of equipping the machine with a rotary tool magazine

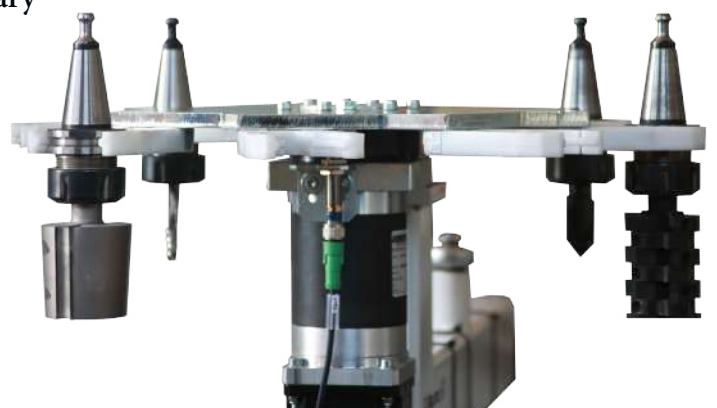
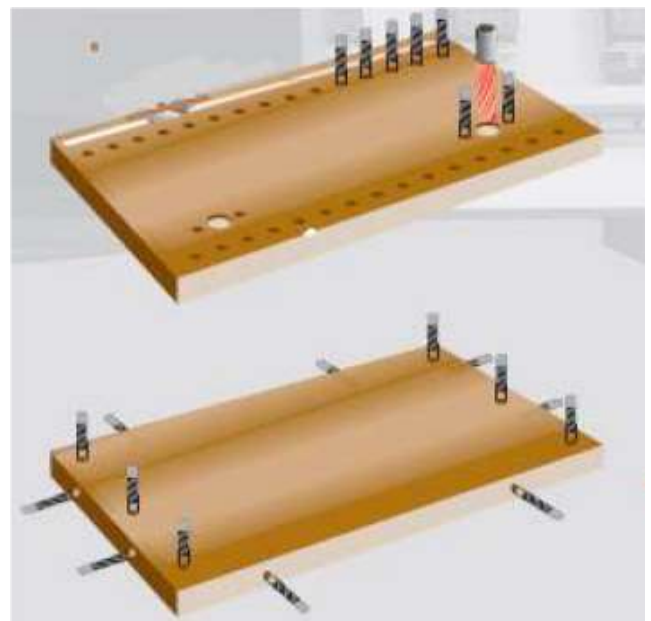
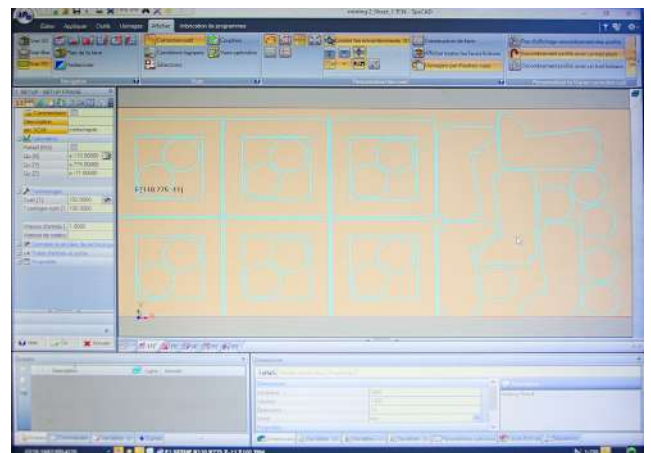

CARACTÉRISTIQUE

*Contrôle moderne et simple d'utilisation
Système Opérationnel Windows 10*

FONCTIONS DE SERIE:

- *Convertisseur automatique de fichiers réalisés avec système CAD et sauvegardés au format DXF*
- *Travail en spécularité sans programmation ultérieure*
- *Perçage contrôlé sur 5 cotés*
- *Programme automatique pour la mortaise de la serrure*
- *Logiciel pour entrer les écritures*
- *Possibilité d'importer/exporter des fichiers au format dxf et iso*
- *Possibilité de créer de nouvelles macros personnalisées meme indépendemment*
- *Programmation paramétrique pour une flexibilité maximale*
- *Création de faces fictives pour les usinages speciaux (usinages effectués sur les faces inclinées non orthogonales.*
- *Affichage graphique pour la position correcte des ventouses*
- *Equerrage*
- *Equerrage avec un rayon de raccord concave et convexe*
- *Fonction de contrôle de la vitesse d'avancement des axes en référence au rayon du profil à effectuer*
- *Macro préenregistrée pour l'usinage de porte*
- *Magasin d'outils automatique*
- *Possibilité d'équiper la machine d'un deuxième magasin d'outils linéaire*
- *Possibilité d'équiper la machine d'un magasin d'outils rotatifs*



Gli spostamenti dei gruppi operatori sugli assi X-Y-Z avvengono su guide lineari prismatiche tramite cremagliera e viti a ricircolo di sfere comandate da motori Brushless e lubrificate automaticamente.

The operating groups move along the X-Y-Z axes on linear prismatic tracks by means of a gear rack and recirculating ball screws driven by Brushless engines and greased automatically.

Déplacement des groupes opérateurs sur les axes X-Y-Z sur guides linéaires prismatiques au moyen de crémaillère et vis à billes gérées par des moteurs Brushless et lubrifiées automatiquement.



Sistema di lubrificazione assi automatica centralizzata gestita dal CN.

Automatic lubrication system of the axes controlled by the CNC.

Le système de lubrification est automatique et géré par le contrôle numérique.



Sistema di misura automatica della lunghezza degli utensili.

Automatic measuring system of the tool length.

Dispositif de calcul automatique de longueur d'outil.

Testa a 5 assi controllati: soluzione ideale per una più vasta gamma di lavorazioni.

5 axis-controlled head: the ideal solution for a wide range of processes.

Perceuse avec 5 axes contrôlés: solution idéale pour un large éventail de processus.

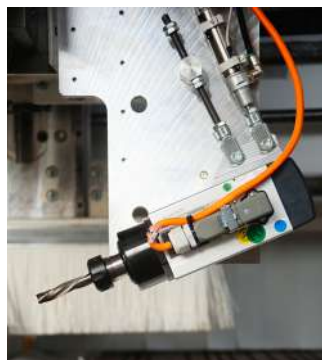

Gruppo fresatore con inclinazione pneumatica da 0 a 22°.

Milling unit with pneumatic inclination from 0 to 22°.

Unité de fraisage avec inclination pneumatique de 0 à 22°.

Gruppo fresatore fisso per serrature.

Fixed milling unit for locks.

Groupe de fraisage fixe pour serrures.



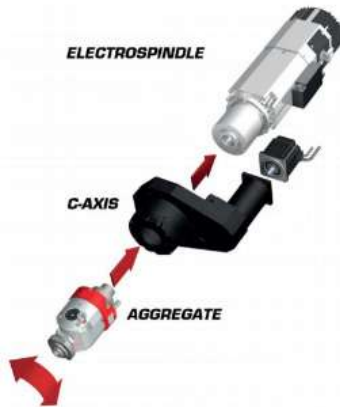

- Asse "C" con sistema di rotazione ad ingranaggi e posizionamento dell'utensile:
- a 360° con testine angolari (optional);
 - rotazione in continuo (l'asse puo' ruotare all'infinito sia in senso orario che antiorario);
 - rotazione con motore brushless, gestita da controllo numerico.

"C" axis with gear rotation system and tool positioning:

- 360 ° with angular heads (optional);
- continuous rotation (the axis can rotate to infinity both clockwise and counterclockwise);
- rotation with brushless motor, managed by numerical control.



Axe "c" avec système de rotation des engrenages et positionnement de l'outil:

- a 360° avec têtes angulaires (en option);
- rotation continue (l'axe peut tourner à l'infini tant en sens horaire qu'anti-horaire);
- rotation avec moteur brushless, gérée par le contrôle numérique.

Possibilità di montare gruppi di foratura con diverse configurazioni.

Possibility of mounting drilling units with different configurations.

Possibilité d'installer des groupes de perçage avec différentes configurations.

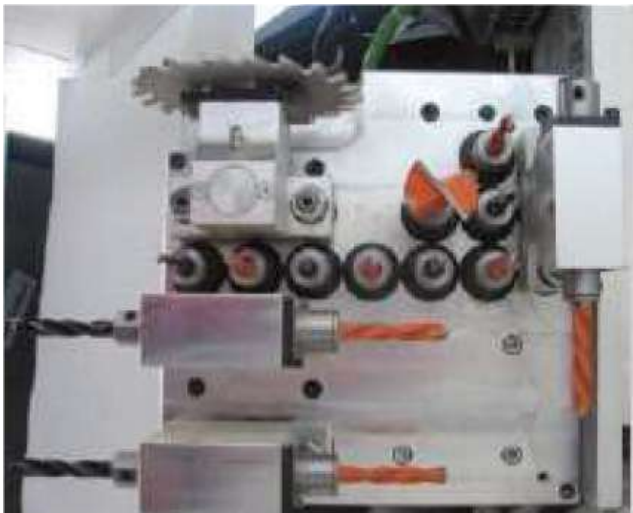

Gruppo di foratura è costituito da mandrini a discesa indipendente con passo 32 mm, utilizzabili sia per le forature frontali che per quelle laterali; una sega circolare garantisce i tagli longitudinali.

The drilling group includes independently lowering spindles with 32 mm pitch, used for both face and side drilling; a circular saw carries out longitudinal cuts.

Le groupe de perçage est constitué de mandrins à descente indépendante, avec un pas de 32 mm, utilisables pour les perçages frontaux et latéraux; une scie circulaire assure les coupes longitudinales.

HR 300

CNC ORIZZONTALE - LINEA LEGNO

Gruppo lama indipendente con rotazione 0°/90°.

Independent blade group with 0° / 90° rotation.

Groupe lame indépendant avec rotation 0°/90°.

Equipaggiamento full:

- asse c
- gruppo fresatore fisso per serrature
- gruppo lama indipendente con rotazione 0°/90°
- testa di foratura a 23 mandrini
- web cam

Full equipment:

- axis c
- fixed milling unit for locks
- independent blade unit with 0° / 90° rotation
- boring head with 23 spindles
- web cam

Équipement complet:

- axe c
- groupe fraiseur fixe pour serrures
- groupe lame indépendant avec rotation 0°/90°
- tête de perçage à 23 broches
- webcam

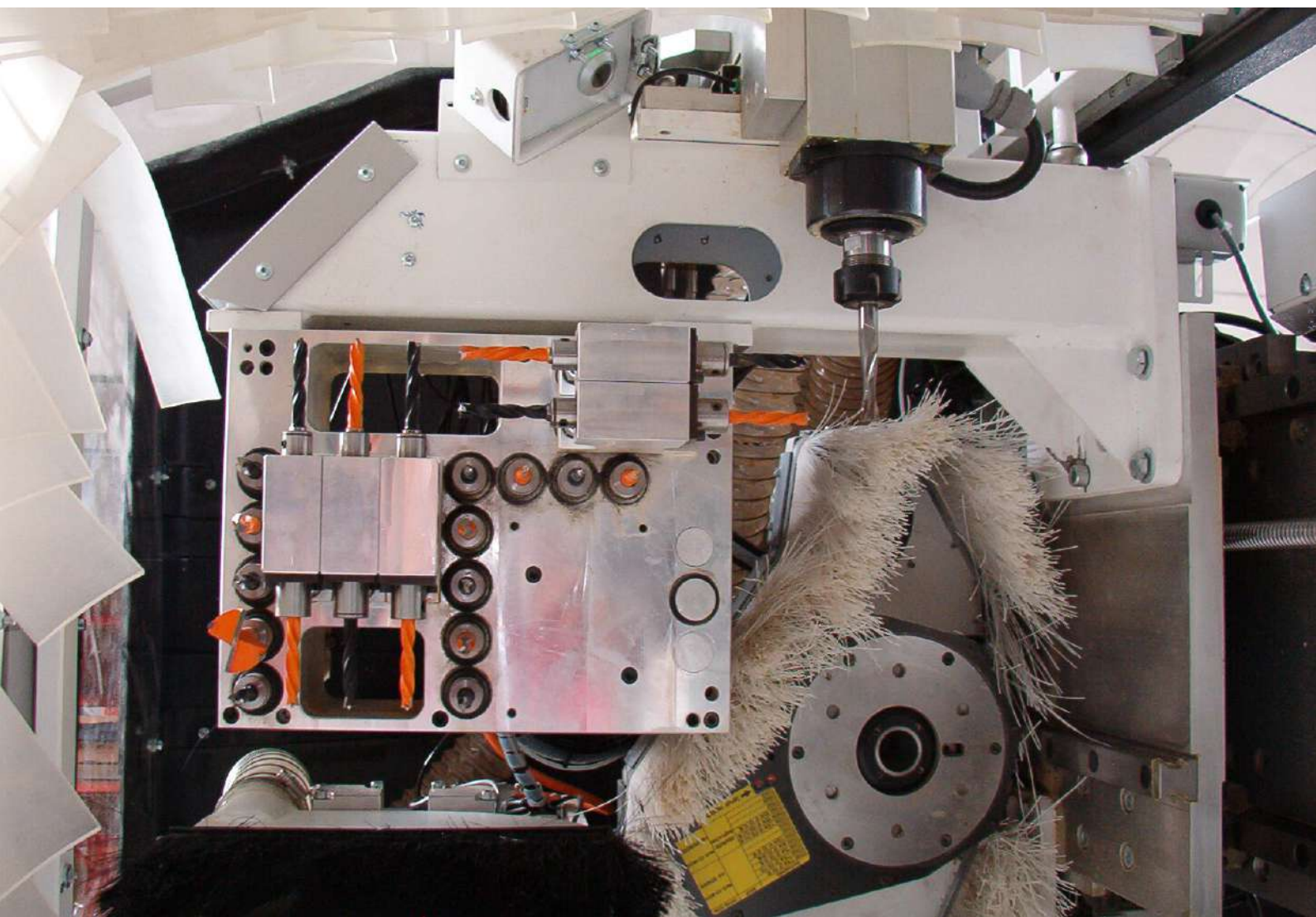
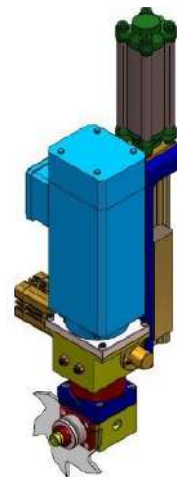

Software:

- 3D ALPHACAM: potente CAD/CAM in grado di gestire geometrie 3D e di realizzare lavorazioni per centri di lavoro a 5 assi interpolanti;
- software specifico per la lavorazione di mobili.

Software:

- 3D ALPHACAM: powerful cad/cam capable of managing 3d geometries and performing machining for 5-axis machining centers interpolating.
- specific software for furniture working.

Logiciel:

- 3D ALPHACAM: cad/cam performant, capable de gérer les géométries 3d et de réaliser des usinages pour les centres d'usinage à 5 axes interpolés;
- logiciel spécifique pour l'usinage de meubles.

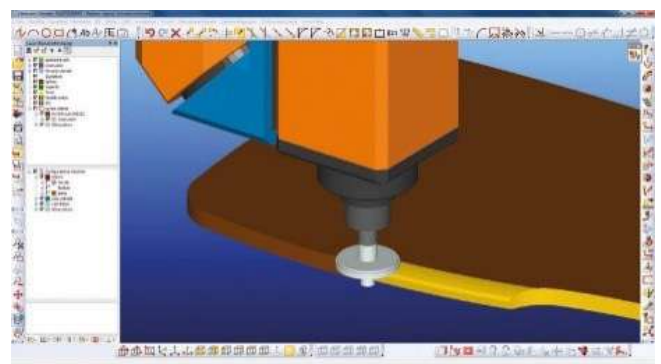
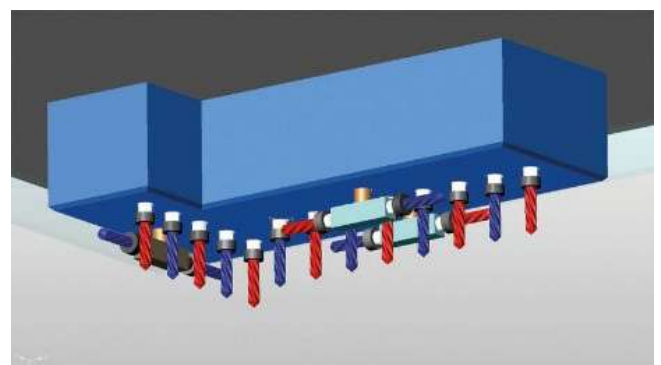
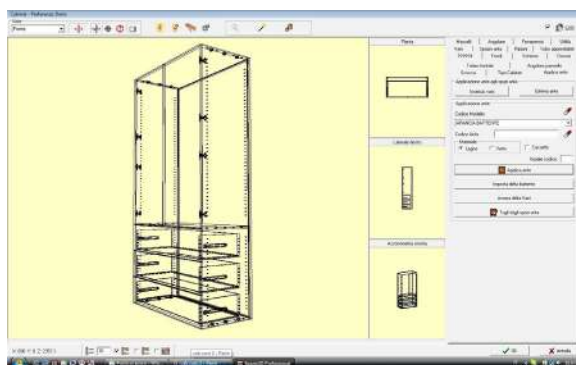
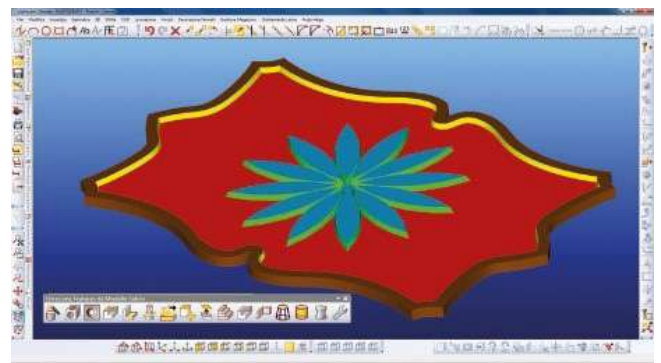
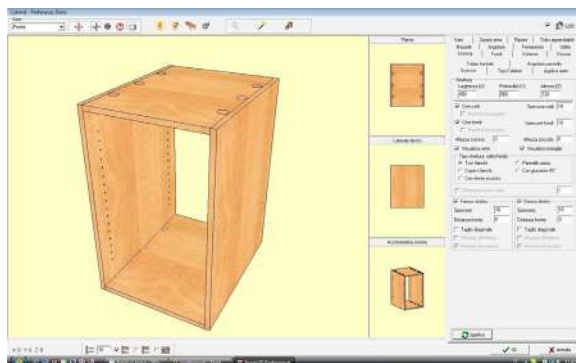
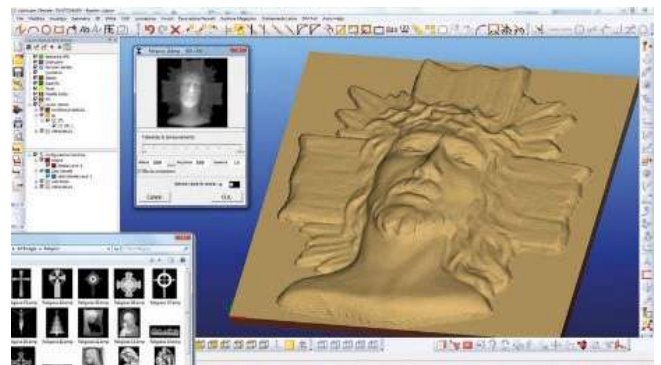
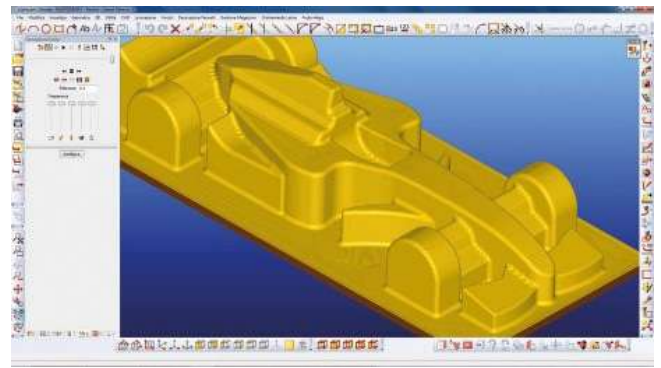

Software nesting:

- gestione della tipologia di materiale: tipo, colore, spessore, ecc.
- gestione di nesting in base alle venature del pannello
- generazione in automatico di etichette identificative dei singoli pezzi con possibilità' di stampa
- generazione in automatico di file di report con tutte le informazioni relative ai singoli pezzi, tipologia di materiale, n° ordine, commessa, ecc. con possibilità' di stampa.

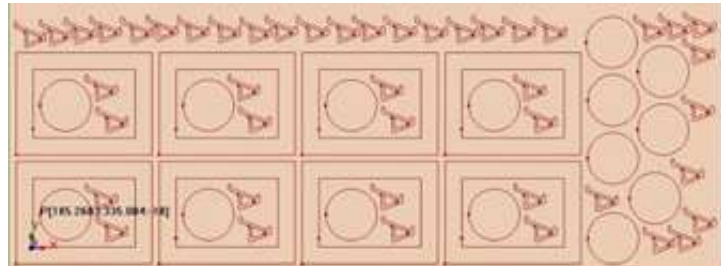
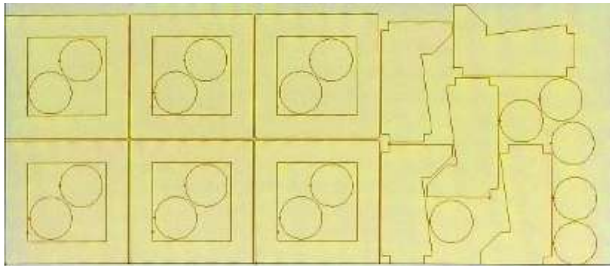

Nesting software:

- management of the type of material: type, color, thickness, etc.
- nesting management based on the grain of the panel
- automatic generation of identification labels of individual pieces with the possibility of printing
- automatic generation of report files with all information relating to individual pieces, type of material, order number, job order, etc. with the possibility of printing.

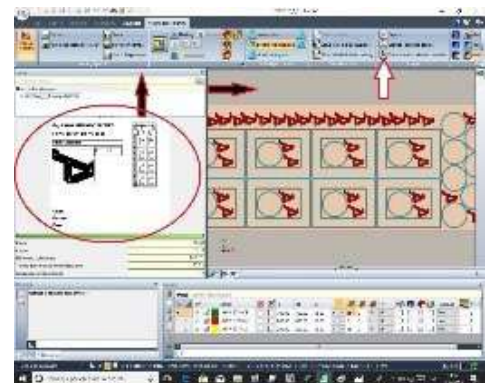

Logiciel nesting:

- gestion du type de matériel: type, couleur, épaisseur, etc.
- gestion de nesting selon les veines du panneau
- génération en automatique d'étiquettes d'identification de pièces uniques avec possibilité de les imprimer
- génération en automatique de fichiers de rapport avec toutes les informations relatives aux pièces unitaires, type de matériel, n. de commande, commande, etc. avec possibilité d'impression.





Dati tecnici | Technical data | Données techniques

Dimensione massima pannello	[mm]	3000 x 1300 x 80
Maximum panel size		
<i>Dimension maximale du panneau</i>		
Velocità asse X	[m/min]	50
X axis speed		
<i>Vitesse axe X</i>		
Velocità asse Y	[m/min]	40
Y axis speed		
<i>Vitesse axe Y</i>		
Velocità asse Z	[m/min]	24
Z axis speed		
<i>Vitesse axe Z</i>		
Velocità rotazione mandrino fresatore	[g/min]	0 - 24000
Milling spindle rotation speed		
<i>Vitesse de rotation du mandrin fraiseur</i>		
Velocità rotazione punta a forare	[g/min]	3.200
Drilling bit rotation speed		
<i>Vitesse de rotation des mèches à percer</i>		
Potenza motore mandrino fresatore	[kW]	11
Milling spindle engine power		
<i>Puissance du moteur du mandrin fraiseur</i>		
Potenza motore punta a forare	[kW]	1,7
Drilling bit engine power		
<i>Puissance du moteur des mèches à percer</i>		
N. mandrini a forare		15
N. of drilling spindles		
<i>N. de mandrins à percer</i>		
Pompa vuoto	[m ³ /h]	100
Vacuum pump		
<i>Pompe à vide</i>		
Potenza elettrica max installata	[kW]	17
Max electrical power installed		
<i>Puissance électrique max installée</i>		
Diametro attacco uscita aspirazione	[mm]	200
Aspiration connection diameter		
<i>Diamètre de la bouche d'aspiration</i>		
Pressione aria compressa	[atm]	6/8
Compressed air pressure		
<i>Pression de l'air comprimé</i>		
Velocità aria per aspirazione	[m/sec]	30
Air speed for suction		
<i>Vitesse de l'air pour l'aspiration</i>		
Consumo aria aspirata	[m ³ /h]	2170
Extracted air consumption		
<i>Consommation d'air aspiré</i>		
Dimensioni imballo macchina	[mm]	4500 x 2150 x 2000
Machine packing dimension		
<i>Dimension de l'emballage de la machine</i>		
Peso netto macchina	[kg]	3000
Machine net weight		
<i>Poids net machine</i>		

Alfatec

machines at your service



Sede legale

Via XX Settembre, 132
47923 Rimini - RN

Sede Operativa

Via Tavoleto 99,
47832 San Clemente - RN



+39 392 77 66 705
+39 0541 410803



info@alfatecsrl.it

www.alfatecsrl.it



Alfatec srl

P. IVA IT04186770402